

Super Series - Model: 208044

Radius Corner

Rear positioned drain holes to maximize usable bowl and cabinet storage space below

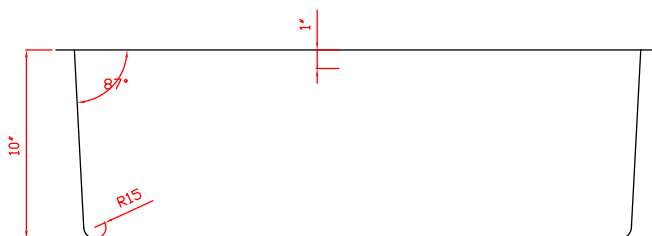
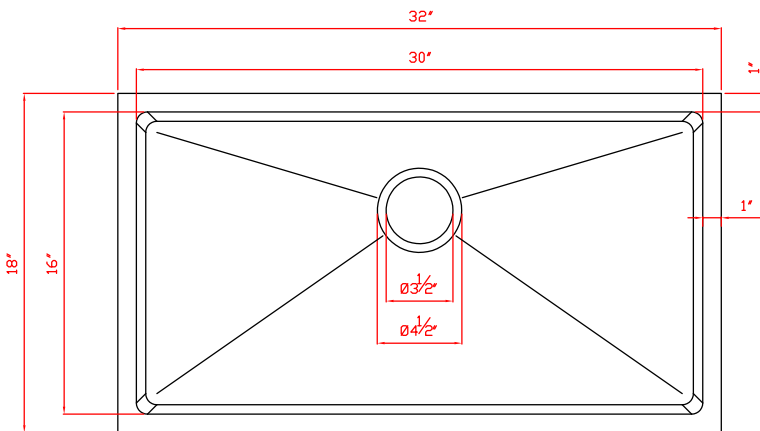

Specifications:

- Handcrafted
- 304 stainless steel 18 gauge
- 18/10 chrome nickel content
- Bowl corner radius of 15mm
- Undermount clips
- Template
- Stainless steel strainer
- 10" Deep

Outside: 32" x 18" x 10"
Inside: 30" x 16" x 10"

Minimum cabinet size 35"

Certification/Warranty

- ASME A 112.19.3
- CSA B45.4
- Limited Lifetime Warranty

Optional Accessories



Model: 202041 - Plate Holder

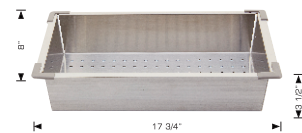

Model: 202040 - Colander



Model: G208044 - Grid



Model: 202020 - Cutting Board

Bosco Canada Inc. is known around the world for producing high quality kitchen sinks that incorporate modern design and functional superiority in every piece they manufacture.