

Builder Series - Model: 208018

Radius Corners

Rear positioned drain holes to maximize usable bowl and cabinet storage space below

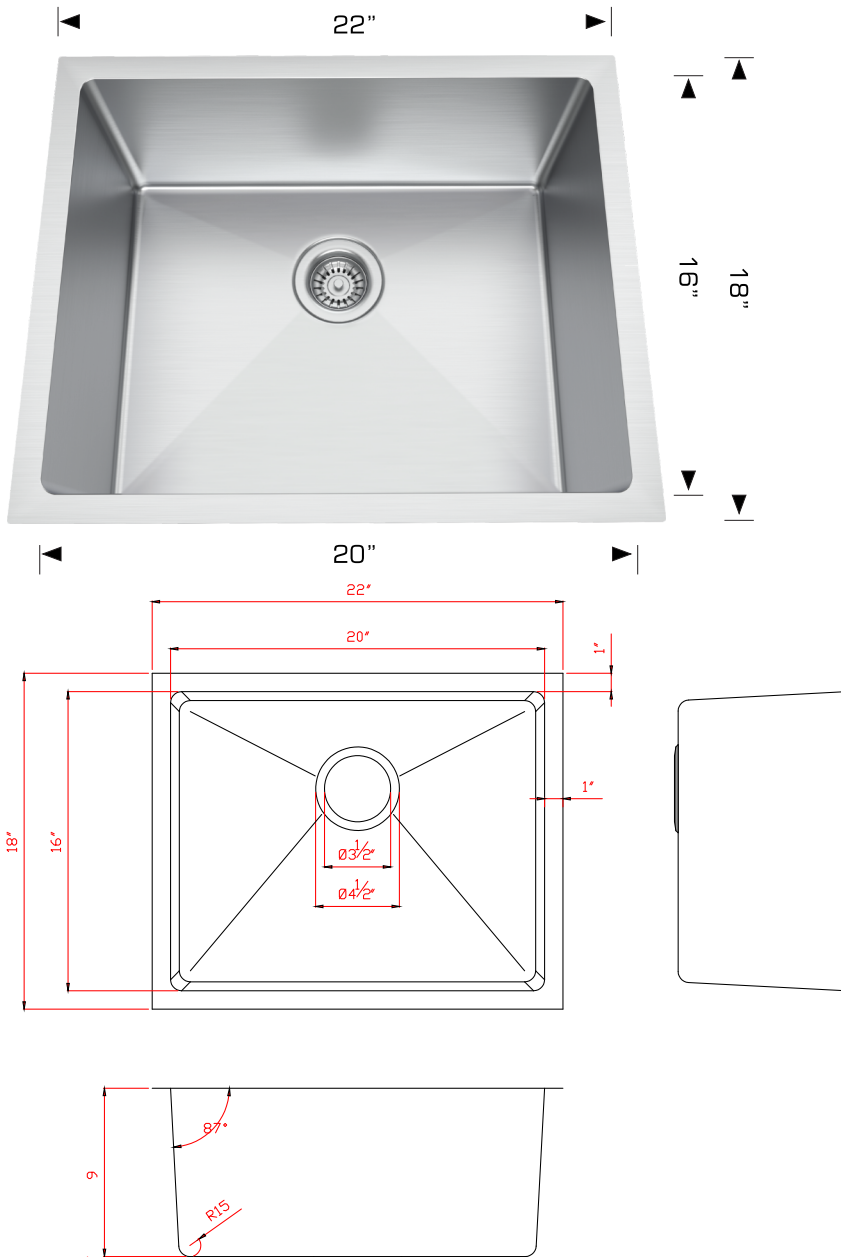

Specifications:

- Handcrafted
- 304 stainless steel
- 16 gauge
- Bowl corner radius of 15mm
- Undermount clips
- Template
- Strainers
- 9" Deep

Outside: 22" x 18" x 9"

Inside: 20" x 16" x 9"

Minimum cabinet size 24"

Certification/Warranty

- ASME A 112.19.3
- CSA B45.4
- Limited Lifetime Warranty

Optional Accessories



Plate Holder
Model: 202041



Colander
Model: 202040



Cutting Board
Model: 202020



Grid
Model: G208018

Bosco Canada Inc. is known around the world for producing high quality kitchen sinks that incorporate modern design and functional superiority in every piece they manufacture.